

Data Sheet

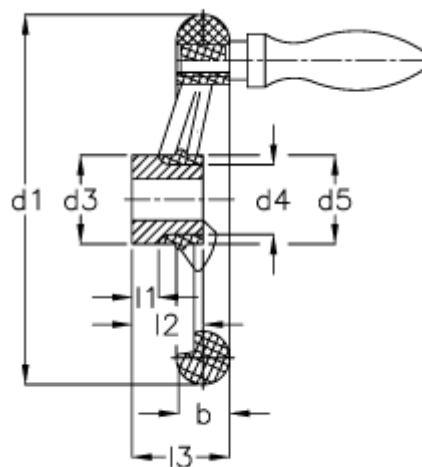

Article number: 20331316
Description: E+G Handwheel
GN 555-160-B16-D

Measures

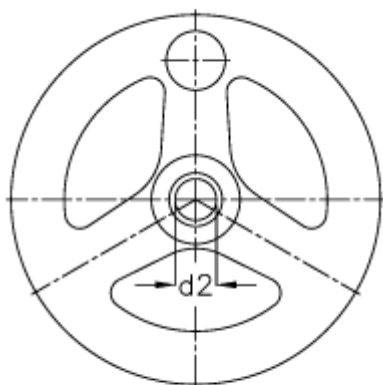

b	= 22	l1 -0.5	= 5
d1	= 160	l2 -0.5	= 28
d2 H7	= 16	l3	= 40
d2 H7	= 14	Number of spokes	= 3
d3	= 32		
d4	= 24		
d5	= 37		
Handle	= 25		